

KIRBO'S OFFICE SYSTEMS

COPIERS • FAX • DIGITAL SYSTEMS

September 3, 2014

Brown County Clerk
200 S. Broadway
Brownwood, Texas 76801

Attention: The Honorable Sharon Ferguson
Subject: Proposal for 2 Canon ImageRUNNER ADVANCE 4245 copiers / printer /
scanners with the following features: 45 page per minute print speed, PCL print,
2,200 sheet paper supply on one and 1,050 sheet paper supply on the other,
network print, network color scan, Hard Drive erase kit, Direct print.

QUOTATION

Included in this quote are the use of the two quoted machines, up to 15,000 pages
per month, all service, parts, labor, and toner. In the event you exceed 15,000 pages
per month the overage rate will be \$0.010 per page.

Cost: \$499.00 per month.

In addition, Kirbo's will provide a Lexmark M5155 at no extra cost to run certificates
that require special paper. The volume will be placed on the 15,000 page inclusion.

The term is year-to-year with a 60 month hard termination date.

If you have any questions please contact me at 643 3383 or my cell 325 642 7823.

Sincerely,

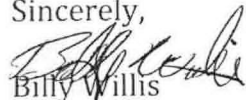

Billy Willis
Kirbo's Office Systems

November 10, 2014
(Exhibit # 5)

September 8, 2014
(Exhibit # 2)

Since 1972

www.kirbos.com

Canon

Authorized Dealer

Brownwood
3005 Hwy. 377 S.
325-643-3383

San Angelo
1202 W. Beauregard
325-658-2679

Harker Heights
617 E. Veterans Memorial Blvd.
254-526-682

Stephenville
234 N. Belknap
254-968-4221

Canon



imageRUNNER
ADVANCE

4251 / 4245 / 4235 / 4225

multifunction printer

compact design

black-and-white copy/print

color scan

Office
Solutions

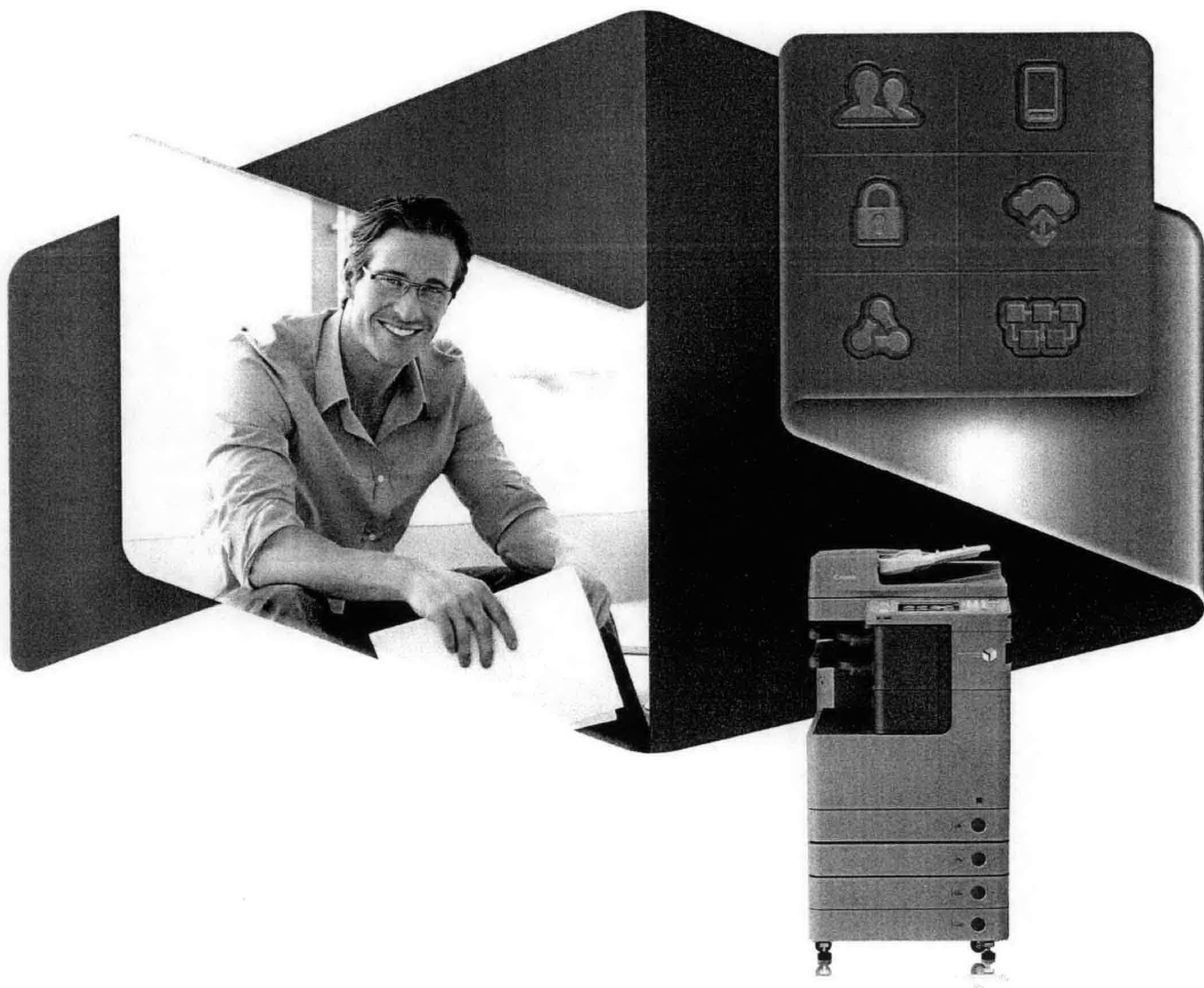

Simply advanced.



imageRUNNER
ADVANCE

4251 / 4245
4235 / 4225

Designed for

**Busy workgroups that demand
outstanding versatility in a
compact space**

Standard Features

Copy/Print/Send/Store

Black-and-White Copy/Print

Color Scan and Send

Print up to 51 ppm (Letter)

Up to 1200 x 1200 dpi

Up to 11" x 17"

4,980-sheet maximum capacity

Scan up to 51 ipm

Flexible in-line finishing options

**Scan directly to Microsoft® PowerPoint®
and Searchable PDF formats**

Hard Disk Drive Lock and Erase, IPsec

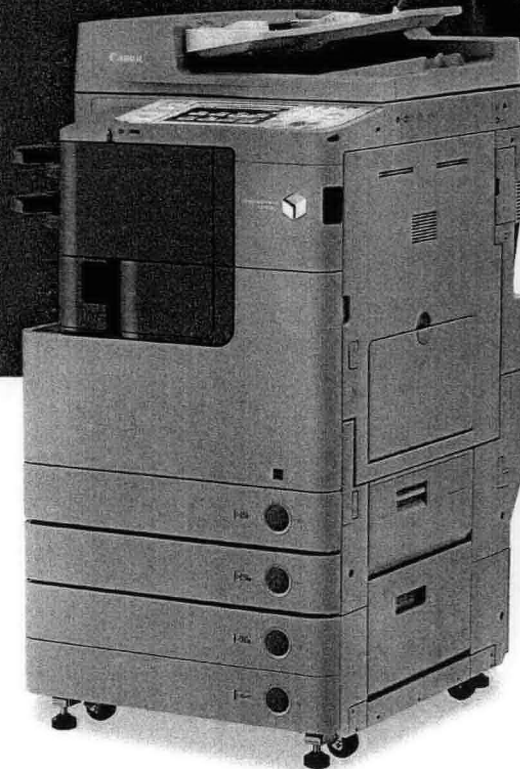

Simply advanced.

The imageRUNNER ADVANCE 4200 Series will propel your business to new levels of performance. A beautifully compact communications hub, it seamlessly integrates business processes and streamlines tasks to achieve impressive efficiency. From every point of view, these models are simply advanced.



People-Centric

An exceptionally intuitive, simple-to-use interface puts access to all functions right at your fingertips, whether at the device or at your desktop.

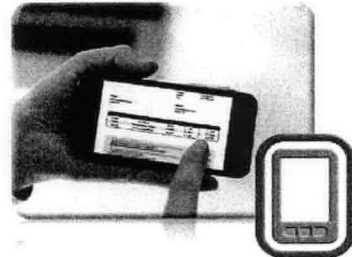

Mobile

Even on the go, you're in control. Print from a laptop, tablet, or smartphone to an imageRUNNER ADVANCE system.



Security

Multilayered solutions help safeguard confidential information and support security compliance.



Cloud-Enabled

A touch of a button on the user interface lets you access, scan to, or print directly from certain cloud applications.



Collaborative

Work better together! Your teams will have the ability to access and leverage the capabilities of other connected imageRUNNER ADVANCE devices on your network.



Connected

Advanced technology and expansive enterprise applications work seamlessly with your device to deliver exceptional results.



People-centric. Business-focused.

The imageRUNNER ADVANCE 4200 Series redefines productivity. Users accomplish tasks quickly and effectively. Applications are easily customized to enhance workflow. And flexible finishing options promise cost-effective, professional-quality documents.

A smart, intuitive interface

The imageRUNNER ADVANCE 4200 Series empowers users. With an impressive range of customizable, simple-to-use, streamlined features, these models help everyone work smarter and faster. A large, 8.4", full-color, high-resolution TFT screen lets users easily view all information.

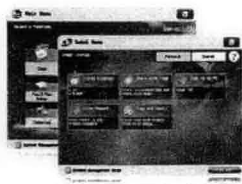
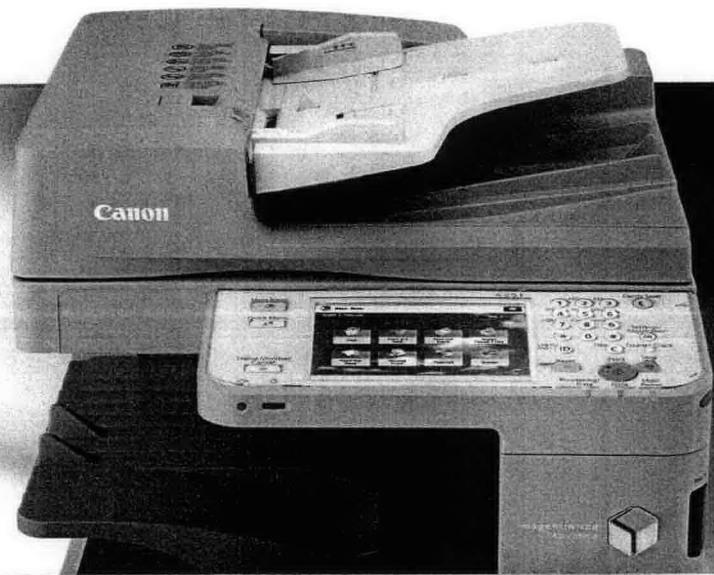

Two menus

Press the Main Menu key for instant access to business-ready functions. Use the Quick Menu to power productivity by combining and accessing routine tasks at the touch of a button.



Customizable

Organize the on-screen buttons to fit the way you work by determining their number, size, and layout. Even display your own logo or special graphic as a screen background.



Web-ready

The optional Web browser lets you go online directly from the device control panel. Just enter a URL to browse pages. Easily output online PDFs.

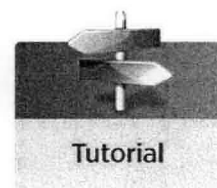

Handy tutorials

Quickly access simple, step-by-step instructions right on the user interface.



Easy Toner Access

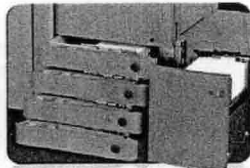

One-button Paper Access



USB Keyboard

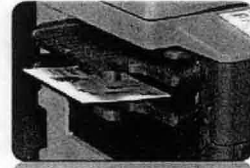

Inner Finisher with Hole-Punching

Designed for ease

Even with its compact size, the imageRUNNER ADVANCE 4200 Series is big on ease of use, including quick-to-replace toner bottles, paper drawers that spring open at the touch of a button, and an optional USB keyboard.

Designed to fit

The imageRUNNER ADVANCE 4200 Series gives you professional-quality output—all within a space-saving footprint. Smartly designed, the models offer an optional internal finisher—and even hole-punching capabilities—while maintaining a compact design.



Engineered for adaptability

These intelligent systems will help you achieve your goals today and in the future. With the ability to smoothly integrate hardware and software solutions, the imageRUNNER ADVANCE 4200 Series lets you personalize applications to meet your organization's changing needs. And it's highly flexible, so you can easily add to, or update, your system with the quick deployment of settings and applications across your enterprise.

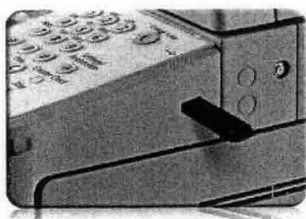
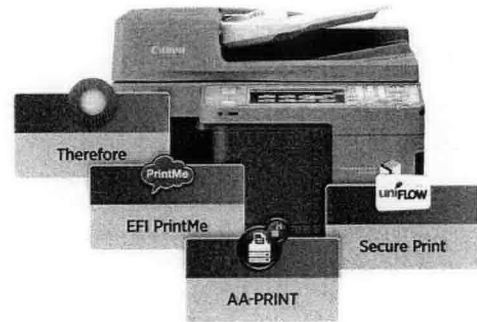

Walk-up convenience

Easily scan to, or print from, a USB thumb drive. Browse folders and rename files. Even expand connectivity options to include memory media, such as an SD card or CompactFlash card.



A consistent experience

No matter which imageRUNNER ADVANCE device you use, you'll enjoy a consistent, simple-to-use experience. All models in the Series use the same interface and print driver.



Seamless connections. Next-generation efficiency.

Imaging and enterprise applications seamlessly integrate. Cloud printing and mobility solutions offer the freedom to work anywhere. Complicated tasks are streamlined and simplified. The imageRUNNER ADVANCE 4200 Series—a truly advanced way to work.



On the go

In an increasingly mobile world, people need the ability to work remotely while maintaining their productivity. Now Canon delivers advanced solutions that keep work flowing effortlessly from wherever you are.



Mobile Devices

Print and scan from your laptop, tablet, and smartphone.* Just log-in at an imageRUNNER ADVANCE device to retrieve your job.



Cloud Portal

Gain quick access to cloud-based applications right from your Canon imageRUNNER ADVANCE device. Simply log in to access or send documents directly from the cloud.



Advanced Anywhere Print

Print to a connected imageRUNNER ADVANCE system. Then conveniently and securely log in at any supported device on the network to view and retrieve your print job with this serverless solution.

*Check for supported devices.

Extensive Print Solutions

Print Options

Canon's proprietary UFR II print technology is standard with these models. Options including Adobe® PostScript® 3™ and PCL 5e/6 are also supported.

Control

Canon's Driver Configuration Tool allows you to set specific defaults and custom profiles. You can also control costs with features such as default duplex printing as well as enhance security by forcing secure print.



Easy collaboration

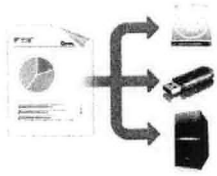

Scan and store documents

Designed to streamline workflow, these models let you readily save, store, and access scanned documents from multiple locations. Store them in built-in spaces, such as Mail Box and Advanced Box, or external spaces, such as memory media or another networked location.

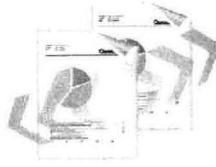

Distribute documents

Distribute scanned documents to multiple destinations, such as e-mail and fax addresses and network folders, all in a single step. Now you can scan and convert both black-and-white and color documents directly into Microsoft® PowerPoint® or a Searchable PDF format. Universal Send supports an expanded range of file formats, including High-Compression PDF/XPS and Encrypted PDF.



Fax documents

These models support up to four fax lines, work with your VoIP network, and have the ability to share the fax function of another networked imageRUNNER ADVANCE model. The Job Forwarding feature automatically routes incoming faxes to other systems, users, or destinations.

Right from your PC

Enjoy even greater control and convenience right from your PC. Use the imageRUNNER ADVANCE Quick Printing Tool to print, fax, preview, and convert files to PDFs, as well as monitor the status of your system—all without even opening an application. The imageRUNNER ADVANCE Desktop solution lets you manage and prepare documents, combine multiple formats, preview files, and select the finishing functions.



Real managed document services

MDS (Managed Document Services)—expert, ongoing optimization of your total document environment—can boost productivity and help deliver big savings. These models are designed from the start to tap into powerful MDS tools and services that track usage, improve printing behavior, identify excessive printing, efficiently manage information and processes, and more. Canon's software solutions and professional services leverage MDS to take your business to the next level.

Streamline your workflow

Canon's middleware technology links enterprise applications, such as Oracle® and SAP®, with Customer Relationship Management systems such as Salesforce.com®. The streamlined workflow automates complex business processes and offers easy access to information, saving both time and money.

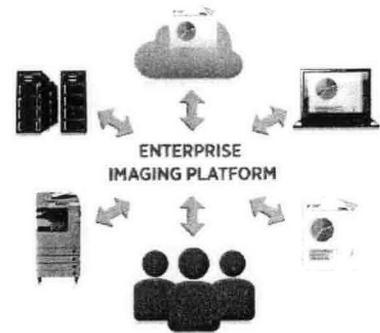



Robust security. Centralized management.

In today's networked world, you need greater control over your resources and data. The imageRUNNER ADVANCE 4200 Series delivers just that with the ability to configure a system, help safeguard information, and track resources, all right at your fingertips.



Powerful command

Canon's device management tools keep you in charge at every step, right from your desktop or through the cloud. Easily install and replace devices, migrate settings and data to new ones, and distribute applications and settings across your network. Monitor a single device with the Remote User Interface or an entire fleet with the imageWARE Enterprise Console. You can even receive alerts when supplies or service are needed.



Safeguard data

From installation to retirement, this Series offers multilayered solutions to help safeguard information and support security compliance. HDD Erase, a standard feature, removes latent images after each task to help safeguard your information during use and at end of life. A security chip with tamper-resistant hardware helps protect passwords and encryption keys. IPsec provides security for data as it traverses the network.

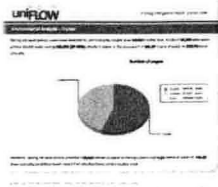

Maximize resources

These systems offer advanced tools to help you track, manage, and influence user behavior. Solutions such as uniFLOW analyze output, encourage double-sided printing, and allocate costs by department, project, or client. You can also route jobs to the most cost-effective device.



Secure authentication

With the need to keep data secure, Universal Login Manager and AA-Print provide a serverless environment where users can print from anywhere within the network to any supported device via log-in authentication. This helps prevent printed documents from being left unattended.

Security Features

- Document Security**
 - Document Scan Lock and Tracking
 - Adobe LiveCycle® Rights Management ES2.5 Integration
 - Encrypted Secured Print
 - Watermark/Secure Watermark
 - Copy Set Numbering
 - Encrypted PDF
 - Digital Signature PDF
 - Fax Forwarding
 - Fax Destination Confirmation
 - Mail Server Security**
 - POP Authentication before SMTP
 - SMTP Authentication
 - Network Security**
 - IP/MAC Address Filtering
 - Port Filtering
 - SSL Encryption
 - Network Application On/Off
 - USB Port On/Off
 - Destination Restriction
 - IPsec
 - IEEE 802.1X (Wire/Wireless)
 - Device Security**
 - IEEE 2600.1 Certification*
 - Data Security**
 - HDD Lock
 - Trusted Platform Module
 - HDD Data Erase and Initialize
 - HDD Data Erase Scheduler
 - HDD Encryption
 - Advanced Box Security
 - Mail Box Password Protection
 - Job Log Conceal
 - Removable Hard Disk Drive
 - Logging/Auditing Security**
 - imageWARE Secure Audit Manager Express
 - Authentication**
 - Department ID/Control Card Systems
 - Device Level Log-in (SSO-H)
 - Access Management System (AMS)
 - Function Level Log-in via AMS
 - Authorized Send
 - Common Access Card (AA-CAC)
 - Universal Login Manager
- Note: Some features may be optional.



Professional quality. Outstanding reliability.

Give your business a real competitive edge with the imageRUNNER ADVANCE 4200 Series. True multitasking power keeps work moving. Custom workflow solutions streamline processes. And professional-quality documents are reliably produced.

Powerful operation

Keep work moving at the speed your business demands. These models have two dedicated processors that work together to accomplish multiple tasks simultaneously. Quick Startup mode minimizes warm-up time, so devices start up promptly.

Lots of uptime

With the imageRUNNER ADVANCE 4200 Series models, you'll enjoy ongoing productivity. Status notifications keep you ahead of the game, and toner and paper can be replaced on the fly. If the correct paper size or stock for a job is unavailable, the system can begin the next job, without delay, to help maximize uptime. If a misfeed occurs while you're scanning, work keeps moving forward without needing to restart from the misfeed location. And easy access to the latest technology and upgrades keeps these models operating at peak performance.

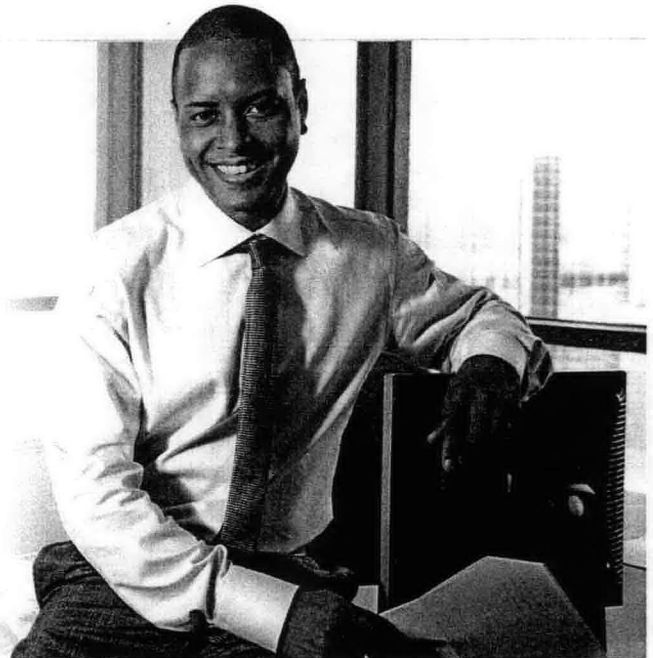

Targeted, integrated solutions

With productivity paramount, the imageRUNNER ADVANCE 4200 Series offers the ability to personalize the way your company gathers, organizes, and disseminates information. Canon's innovative MEAP® platform lets you develop custom solutions to meet specific workflow needs. And new levels of connector and link support enhance communication with existing systems as well as those you may acquire in the future.



Standout results

Make a great impression with professional-quality reports, manuals, newsletters, and contracts. The imageRUNNER ADVANCE 4200 Series gives you the ability to generate high-quality documents in-house. Produce crisp black-and-white images and finish documents easily, all while enjoying outstanding convenience and impressive cost savings.



Strong commitment. Eco-conscious solutions.

The imageRUNNER ADVANCE 4200 Series incorporates innovative, eco-conscious features that keep your business operating efficiently while helping to reduce your environmental footprint.



A responsible way to work

Canon knows that the world and the workplace need a greener workflow, and the imageRUNNER ADVANCE 4200 Series, rated EPEAT® Silver, delivers just that. Now you can seamlessly share and distribute digital documents as well as preview files to make changes prior to printing, all of which help to reduce the use of paper and toner. Print drivers are defaulted to duplex documents to encourage two-sided printing and reduce waste. And with Secure Print, documents are sent to a device but not printed until a password is entered, further contributing to paper waste reduction.



Eco-conscious design

Canon is making a difference through creative, ecological thinking. These imageRUNNER ADVANCE models employ certain components that are made with recycled plastic from retired products. And, Canon's innovative green technologies also include bio-based plastic, a plant-derived compound that replaces certain petroleum-based plastic parts.

A clear strategy

Greater energy efficiency

From the inside out, the imageRUNNER ADVANCE 4200 Series is designed for high-energy efficiency and stellar performance. The combination of Canon's fusing technologies and toner helps lower overall energy consumption by minimizing power requirements and reducing energy use during warm-up and standby modes. With advanced technologies present in each model, the Series also meets ENERGY STAR® standards.



Minimize environmental impact

All suppliers are required to meet Canon's stringent Green Procurement policy and environmental terms. This helps the company exceed the toughest global standards set by the EU RoHS Directive, which restricts the use of certain hazardous substances.



Reduction of CO₂ emissions

Through its Life Cycle Assessment System, Canon has lowered CO₂ emissions by focusing on each stage of the product life cycle, including manufacturing, energy use, and logistics. These products are designed to be the smallest and lightest in their class, with less packaging to help make transportation more efficient.



Designed for outstanding versatility

Finishing Options

- A** Booklet Finisher-G1
 - 2-tray, 3,000-sheet capacity
 - Corner and double stapling, up to 50 sheets
 - Booklet-making, up to 16 sheets
- B** External 2/3-Hole Puncher-B2*
 - 2- and 3-hole punching

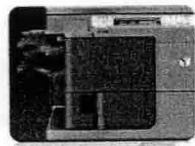

Inner Finisher-D1 with 2/3-Hole Puncher-A1 and Optional Inner Finisher Additional Tray-A1

- 600-sheet capacity**
- 2- and 3-hole punching
- Corner and double stapling, up to 50 sheets

Staple Finisher-G1

- 2-tray, 3,000-sheet capacity
- Corner and double stapling up to 50 sheets

Other Finishing Options:
Inner 2-way Tray-H1

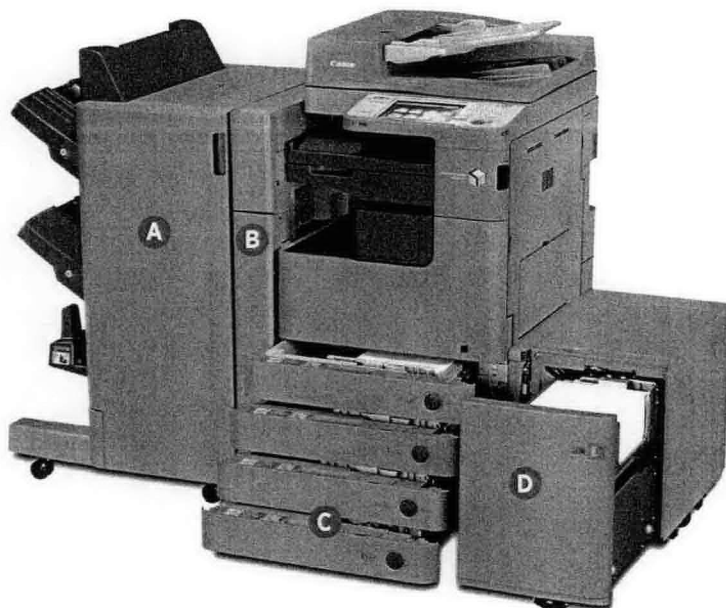

Paper Feeding Options

- C** Cassette Feeding Unit-AF1
 - 550-sheet x 2-cassette capacity
 - 16 lb. Bond to 34 lb. Cover
 - Supports up to 11" x 17"
- D** Paper Deck Unit-B2
 - 2,700-sheet capacity
 - 16 lb. Bond to 34 lb. Bond
 - Supports letter-sized paper



Envelope Feeder Attachment-D1

- 50-sheet capacity
- Supports COM10 No.10, Monarch, DL, ISO-B5

Printer Options***

- PCL Printer Kit-AY1
- PS Printer Kit-AY1
- Direct Print Kit (for PDF/XPS)-H1

Security Options

- Universal Send Security Feature Set-D1
- Universal Send Digital User Signature Kit-C1
- Encrypted Secure Print-D1
- Removable HDD Kit-AJ1
- Secure Watermark-B1
- Document Scan Lock Kit-B1
- HDD Data Encryption and Mirroring Kit-C4
- HDD Data Erase Scheduler
- iR-ADV Security Kit-K1 for IEEE 2600.1 Common Criteria Certification†

Accessibility Options

- Remote Operators' Software Kit-B1



- Voice Operation Kit-C2
- Voice Guidance Kit-F2
- Braille Label Kit-F1
- ADF Access Handle-A1

* Requires Staple Finisher-G1 or Booklet Finisher-G1.
** 1000-sheet capacity when Inner Finisher Additional Tray-A1 is not attached.
*** UFR II standard.
† Not available at time of launch.

Note: For additional options and specifications, please refer to the back page.

Main Unit

Operation Panel: 8.4" SVGA Full-Color TFT Screen

Memory

Standard: 1.25GB RAM
Maximum: 1.75GB RAM

Hard Disk Drive

Standard: 160GB
Maximum: 1TB

Network Interface Connection

Standard: 10/100/1000Base-TX
Optional: Wireless LAN

Other Interface

Standard: USB 2.0 (Host) x2, USB 2.0 (Device)
Optional: Device Port [USB 2.0 (Host) x 2],
Copy Control Interface

Copy/Print Speed (Letter)

4251: Up to 51 ppm
4245: Up to 45 ppm
4235: Up to 35 ppm
4225: Up to 25 ppm

First-Copy-Out Time (Letter)

4251: 3.7 Seconds
4245/4235: 3.8 Seconds
4225: 5.2 Seconds

Paper Sources (20 lb. Bond)

Standard: Dual 550-sheet Paper Cassettes,
80-sheet Stack Bypass
Maximum: 4,980 Sheets

Output Paper Capacity (20 lb. Bond)

Standard: 250 Sheets (Inner Tray)
Maximum: 3,100 Sheets (w/Staple Finisher or Booklet Finisher)

Output Paper Sizes

Cassette 1: Legal, Letter, Letter-R, Statement-R, Executive,
Custom Size (5-1/2" x 7-1/8" to 11-3/4" x 15-3/8")
Cassettes 2/3/4: 11" x 17", Legal, Letter, Letter-R, Statement-R,
Executive, Custom Size (5-1/2" x 7-1/8" to
11-3/4" x 17")
Bypass: 11" x 17", Legal, Letter, Letter-R, Statement-R,
Executive, Custom Size (3-7/8" x 5-7/8" to
11-3/4" x 17")

Acceptable Paper Weights

Cassettes: 16 lb. Bond to 34 lb. Bond (60 to 128g/m²)
Bypass: 14 lb. Bond to 80 lb. Index (52 to 220g/m²)

Warm-up Time

From Power On: 30 Seconds
From Sleep Mode: 10 Seconds
Quick Startup Mode: 7 Seconds*

Power Requirements/Plug

120V AC, 60Hz (10.4A/NEMA 5-15P)

Dimensions (H x W x D)

4251/4245: 35-1/2" x 22-1/4" x 27-7/8" (909mm x 565mm x 708mm)*
4235/4225: 30-3/8" x 22-1/4" x 27-5/8" (771mm x 565mm x 700mm)

Installation Space (W x D)

(when the Multi-Purpose Tray is extended)
4251/4245: 34-1/2" x 27-7/8" (876mm x 708mm)*
4235/4225: 34-1/2" x 27-5/8" (876mm x 700mm)

Weight (Includes consumables)

4251/4245: Approx. 172 lb. (77.9kg)*
4235/4225: Approx. 154 lb. (70kg)

Toner (Estimated Yield @ 6% Coverage)

4251/4245: 34,200 Images
4235/4225: 30,200 Images

Document Feeder

Scan Method

Duplexing Automatic Document Feeder
(Standard on 4251/4245, Optional on 4235/4225)

Acceptable Originals

Paper Size: 11" x 17", Legal, Letter, Letter-R, Statement

Scan Speed (BW/Color; Letter)

Simplex: 51/51 ipm (300 dpi)
51/30 ipm (600 dpi)**

Paper Capacity (20 lb. Bond)

100 Sheets

Print Specifications

Engine Resolution: 1200 x 1200 dpi

PDL Support

Standard: UFR II
Optional: PCL 5e/6, PCL 6, Adobe PS 3

Print Driver Supported OS

UFR II, PCL 5e/6, Adobe PS 3:
Windows* (XP/Windows Vista*/7/8), Windows Server
(2003/2008/ 2008 R2/SBS 2011/2012), Windows Terminal
Servers, Microsoft* Clustering Server, Citrix, Macintosh*
(OS X 10.5.8 or later, UFR II and PS 3 only), VMware, SAP
(PS and PCL Only)

Direct Print Support

Standard: TIFF, JPEG
Optional: PDF, EPS,*** XPS*

Universal Send Specifications

Sending Method

E-Mail, I-Fax, File Server (FTP, SMB, WebDAV), Mail Box,
Super G3 Fax (Optional), IP Fax (VoIP) (Optional)

Communication Protocol

File: FTP (TCP/IP), SMB (TCP/IP), WebDAV
E-mail/I-Fax: SMTP, POP3, I-FAX (Simple, Full)

File Format

Standard: TIFF, JPEG, PDF, PDF/XPS (Compact),
PDF (Apply Policy), PDF (Optimize for Web),
PDF/A-1b, XPS, PDF/XPS (OCR), OOXML (.pptx)
Optional: PDF (Trace & Smooth), PDF (Encrypted),
PDF/XPS (Digital Signature)

Fax Specifications

Maximum Number of Connection Lines: 4

Modem Speed

Super G3: 33.6 Kbps
G3: 14.4 Kbps

Compression Method: MH, MR, MMR, JBIG

Sending/Recording Size: Statement to 11" x 17"

Store Specifications

Mail Box (Number supported)

100 User Inboxes, 1 Memory RX Inbox,
50 Confidential Fax Inboxes

Advanced Box

Available: Approx. 15GB (Standard HDD)
Disk Space: Approx. 629GB (1TB HDD)
Communication Protocol: SMB or WebDAV
Supported Client PC: Windows* (Windows 2000/XP/Windows Vista*/7)

Memory Media

Standard: USB Memory
Optional: SD, SDHC, CompactFlash*, Memory Stick,
Microdrive

Security Specifications

Standard

Department ID Management, Single Sign On-H, Access
Management System (Device and Function Level Log-in),
Secured Print, Trusted Platform Module, User Access Control
of Advanced Box, Mail Box Password Protection, IPv6, Restricting
Features (Restricting the Send Function, Restricting New
Addresses on Address Book), SSL Encrypted Communication,
SNMPv1/v3, MAC/IP Address Port Filtering, SMTP Authentication,
POP Authentication before SMTP, HDD Initialize (up to 9X),
HDD Erase (Up to 3X), HDD Lock, IPsec, Adobe LiveCycle* Rights
Management ES2.5 Integration

* If "Quick Startup Settings for Main Power" is set to ON, it takes seven seconds
until the key operation on the touch-panel display is available after turning on
the main power, and 10 seconds until the start button function is available.

* Includes DADF

** Standard color scan support is for 100 dpi and 300 dpi. Up to 600-dpi
scanning requires Additional Memory Type A (512MB).

*** EPS can be printed directly only from the Remote User Interface.

* XPS cannot be printed directly from the Web Access Software.

NOTE: Some accessories require additional equipment or may be prerequisites
for other options. Some accessories cannot be installed simultaneously. Check
with your Canon Authorized Dealer for details.

Canon

1-800-OK-CANON
www.usa.canon.com

Canon U.S.A., Inc.
One Canon Park
Melville, NY 11747

As an ENERGY STAR® Partner, Canon U.S.A., Inc. has qualified these models as meeting the ENERGY STAR energy efficiency criteria through an EPA recognized certification body. ENERGY STAR and the ENERGY STAR mark are registered U.S. marks. CANON, IMAGERUNNER, MEAP, and the GENUINE logo are registered trademarks of Canon Inc. in the United States and may also be registered trademarks or trademarks in other countries. IMAGEWARE is a registered trademark of Canon U.S.A., Inc. in the United States and is a trademark of Canon Inc. in certain other countries. All other referenced product names and marks are trademarks of their respective owners and hereby acknowledged. Specifications and availability subject to change without notice. Products are not manufactured for outdoor use; depiction of such is for artistic purposes only. Products shown with optional accessories. All printer output images are simulated. Canon U.S.A. does not provide legal counsel or regulatory compliance consultancy, including without limitations, Sarbanes Oxley, HIPAA, GLBA, Check 21 or the USA Patriot Act. Each customer must have its own qualified counsel determine the advisability of a particular solution as it relates to regulatory and statutory compliance.
©2013 Canon U.S.A., Inc. All rights reserved.

0179W984
0913-4200SR5-50M-DMC



Lexmark® K1100 Series Monochrome Laser Printer



Superior Performance.



Mono



4.3-inch or
7-inch Touch
Screen



Solutions



Security



Network



Duplex
Printing



Up to
70 ppm



Direct
USB



Finishing
Function

LEXMARK[™]

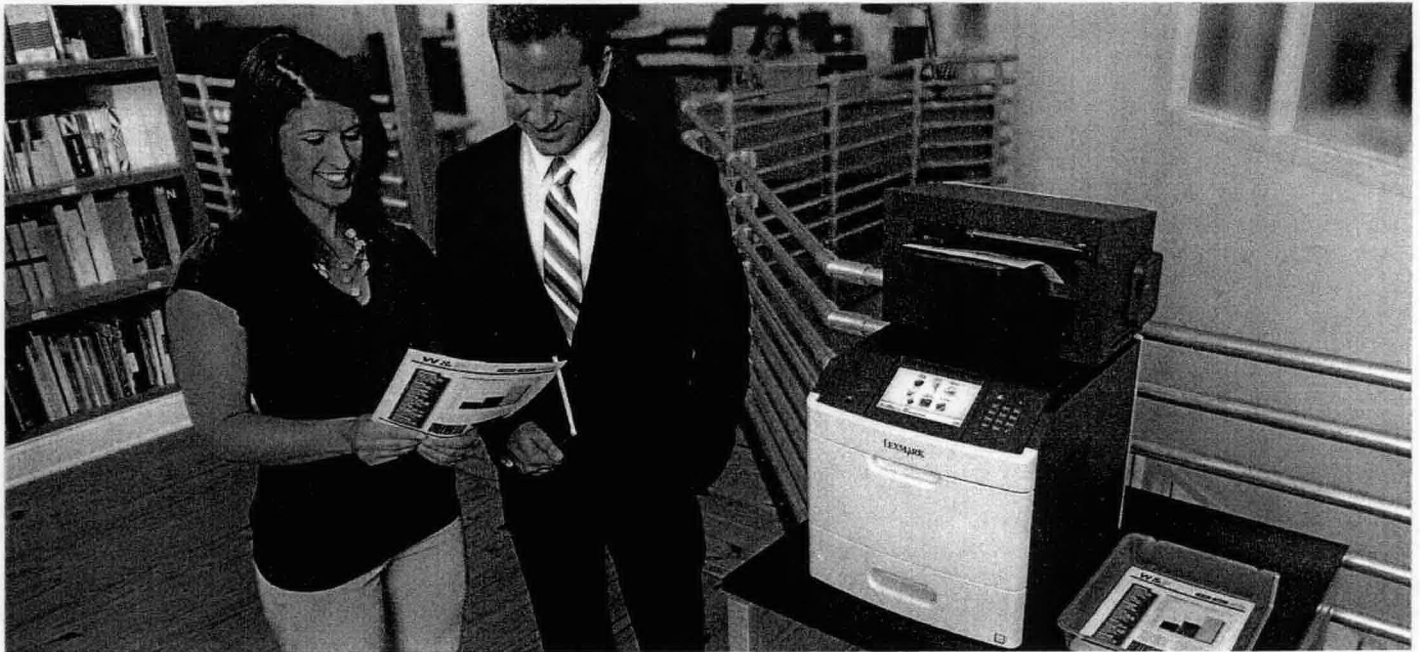

Lexmark M5100 Series



Why Lexmark.

Founded in 1991 from an IBM heritage in Lexington, Kentucky, Lexmark is focused on delivering tailored solutions to solve the unique challenges businesses face. Lexmark's broad portfolio of high quality products, solutions, and services help improve productivity, increase efficiency and empower employees to perform at their best.



Eco-responsible.

Printing responsibly and reducing the impact of printing on the environment is a win for your business and your budget. Our goal is to design, package and deliver innovative products and solutions that produce high quality output with reliable performance. And at the same time, help you minimize the number of cartridges you use over the life of a printer and conserve paper and energy.

The Lexmark Cartridge Collection Program provides a variety of methods for free returns of your empty cartridges to Lexmark or our collection partners. Program availability and details vary by country.



Environmental protection is a shared responsibility.

Through work with industry groups, Lexmark helps guide the formation of standards and guiding principles for environmental sustainability.

Our memberships include

AeA Europe
Ecma International
Electronics Industry Citizenship Coalition (EICC)
DIGITALEUROPE
Information Technology Industry Council (ITI) Environmental Leadership Council



Lexmark M5100 Series Overview



Superior performance. The Lexmark M5100 Series can satisfy the needs of the busiest work environments. A choice of configuration options and productivity solutions gives your business exactly what it needs to get more done. More value, greater versatility.

- Process even the most complex jobs utilizing the 800MHz dual-core processing power and up to 2.56 GB of memory
- Get work done quickly with print speeds up to 70 ppm and produce your first page in as little as 4 seconds
- Produce professional output with a system that delivers consistent image quality on a diverse range of materials
- Instant warm-up fuser helps reduce energy consumption and improve time to first page



Powerful productivity. The Lexmark M5100 Series combines exceptional performance with time-saving applications designed to drive greater efficiency and simplify your work processes.

- With this system, you can print from desktops as well as mobile devices that can run applications*
- A maximum input capacity of up to 4,400 sheets and our state-of-the-art paper handling keeps jobs moving with reliable performance
- Select from a number of output options and finishing features including a four-bin user-assignable mailbox, high capacity output expander, or staple finisher

*Optional software available. Licensing fees may apply.



Easy and intuitive. The Lexmark M5100 Series is designed for easy operation to allow you to stay focused on customer engagements instead of routine maintenance.

- Easy to navigate 4.3-inch or 7-inch color touch screen provides audible feedback to make completing tasks intuitive
- Print preview features help you select documents or specific pages within a document
- Extend your environmental responsibility with energy-efficient settings such as the Hibernate Mode which reduces the energy usage to less than one watt
- Manage your devices with available software

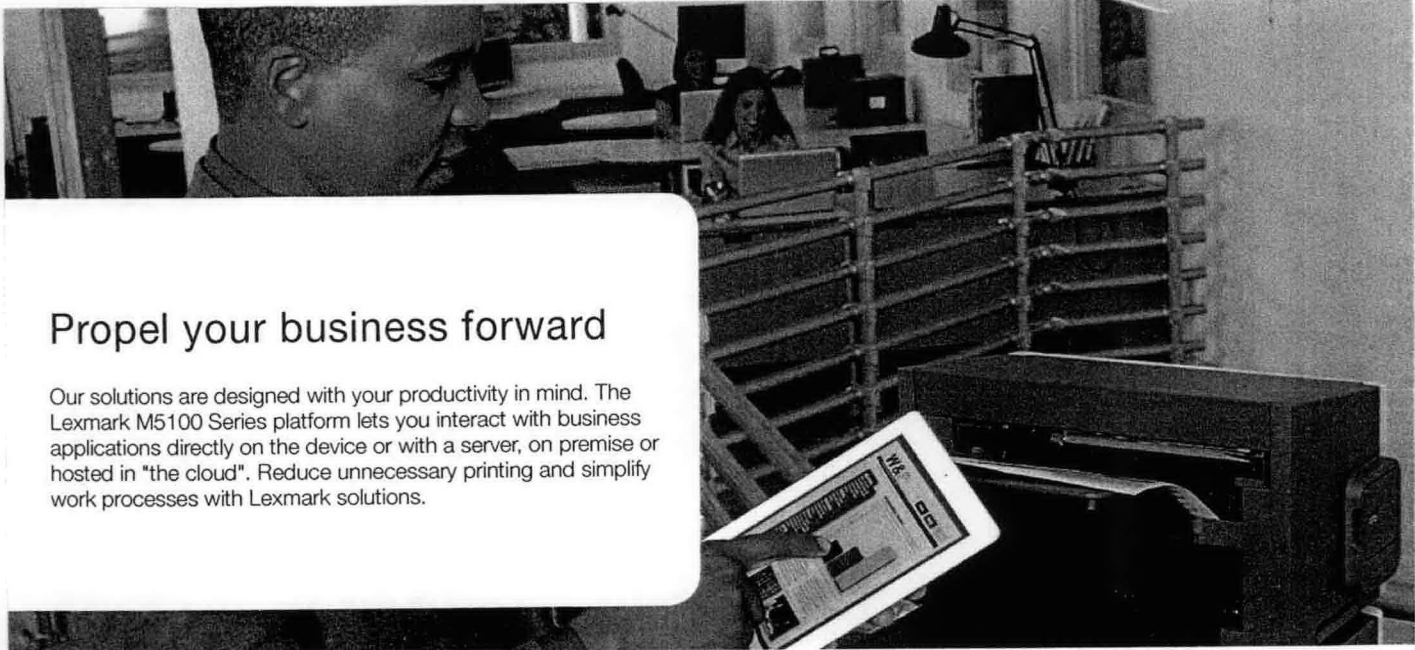

Propel your business forward

Our solutions are designed with your productivity in mind. The Lexmark M5100 Series platform lets you interact with business applications directly on the device or with a server, on premise or hosted in "the cloud". Reduce unnecessary printing and simplify work processes with Lexmark solutions.

Lexmark M5100 Series Solutions

Navigate to efficiency. The Lexmark color touch screen is a key access point to your device. The easy to read, customizable, 4.3-inch or 7-inch interface gives you the ability to preview thumbnails of documents prior to printing, as well as change print jobs at the device. You can even view, select and print specific pages within a document directly from the touch screen. Its easy-to-use, intuitive navigation provides fast access to the functions and shortcuts.

The following are examples of preloaded solutions on M5100 Series printers.



4.3" TOUCH SCREEN



7" TOUCH SCREEN

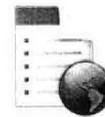

Forms and Favorites

Eliminate waste and inefficiencies associated with preprinted forms. Store frequently printed forms, marketing materials or other documents online, then print them on demand.



Eco-Settings

Lets you change up to six different device settings to enhance environmental savings: Eco-Mode, two-sided printing, time to standby mode, time to Power Saver mode, screen brightness, and Quiet Mode.



Customer Support

This application provides you with an easy way to send information about your device to your authorized dealer or internal help desk.



Manage Address Book

Manage Address Book allows the Administrator to import and export e-mail shortcuts and fax shortcuts from a CSV file.

Additional Lexmark solutions are available through your authorized Lexmark Business Solutions Dealers.



Lexmark M5100 Series Vertical Solutions



Professional quality output is only part of the story

By leveraging our industry expertise, you can generate efficiency and reduce costs across business processes and gain the power you need to move ahead. Lexmark technology solutions are tailored to your business environment, to where business interactions and decisions are happening.

Empower your employees with workflow solutions that refine work processes, capture critical information, and deliver information to the right place, at the right time, and in the right format.

Contact your Lexmark Business Solutions Dealer for specific vertical solutions*. Solutions are customized through your dealer.

* Optional software available. Licensing fees may apply.

Keep sensitive information and documents secure

Lexmark builds network devices with security in mind to protect your data and documents throughout your entire workflow. Our wide range of security functions include device management, device hardening and device operation.

Device management. Tools include administrative access and passwords, HTTPS, SNMPv3, IP security (IPSec), and 802.1x support to remotely monitor and manage device usage.

Device hardening. Includes port filtering, TCP connection filtering, hard disk encryption, hard disk wiping and digitally signed firmware updates that enhance the security of the device's network interface.

Device operation. Reduce vulnerabilities with authentication and authorization features, address book lookup via LDAP over SSL and device lockout for protection of user information.

Lexmark has shown its strength and leadership with respect to security.

- Forming and chairing the group that created the IEEE 2600 standards for security on hard copy devices.
- Becoming the first hard copy device manufacturer to take a holistic approach with the National Information Assurance Partnership (NIAP) Common Criteria evaluation.

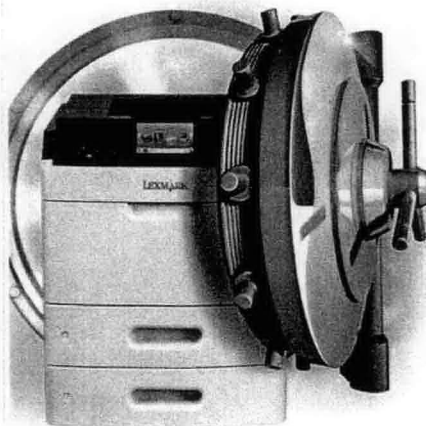

Lexmark M5100 Series Key Features

Features that help you optimize your work

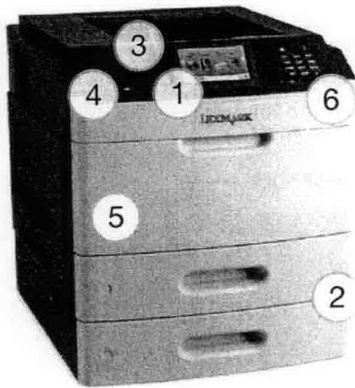

M5163 model with 4.3-inch color touch screen



1) Intuitive color touch screen

Operate your device with ease through smart and intuitive navigation. Receive audible feedback to confirm your actions.



2) Flexible media handling

Produce projects like a pro with built-in 2-sided printing, the ability to print on diverse materials, plus finish the job with your choice of multiple finishing options.



3) Lexmark Solutions

Reduce unnecessary printing and simplify work processes through solutions applications preloaded on your device. Choose additional Lexmark solutions to fit your unique workflow needs.



4) Direct USB

The front USB port allows for convenient walk-up preview, printing and is compatible with most printable image file formats.



M5170 model with 7-inch color touch screen



5) Lexmark's Unison™ Toner

Advanced toner science – powerful enough to deliver consistently outstanding image quality, with a shake free print system.



6) Eco-friendly features

Easy-to-access features like Eco-Mode to reduce paper and toner consumption, the Sleep Button and Hibernate Mode make it easy to print responsibly and help you save energy.

Lexmark M5100 Series Ordering Information

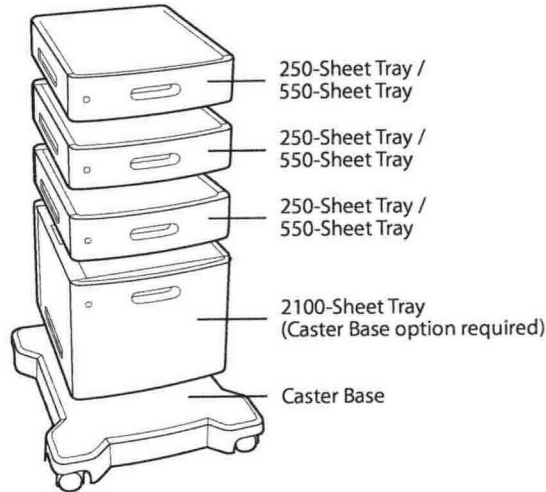
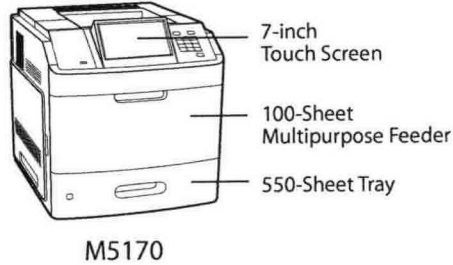
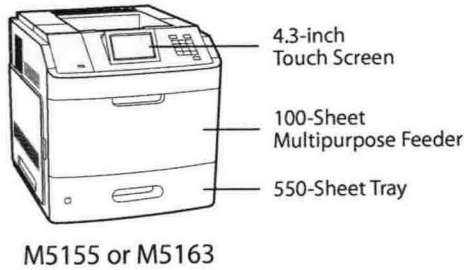

Output Options:



Staple Finisher



High Capacity Output Expander



Up to 3 4-Bin Mailboxes



Up to 3 Output Expanders

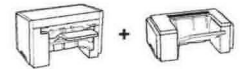

Staple Finisher + Output Expander

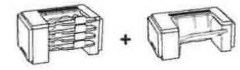

4-Bin Mailbox + Output Expander

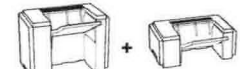

High Capacity Output Expander + Output Expander

- Standard
- Optional

M5100 Series

- 40G0720** Lexmark M5155
40G0730 Lexmark M5163
40G0740 Lexmark M5170

- 24B6015** M5155, M5163, M5170, XM5163, XM5170 Toner Cartridge
24B6025 M5155, M5163, M5170, XM5163, XM5170 250-Sheet Tray Insert
25A0013 M5155, M5163, M5170, XM7155, XM7163, XM5170 Staple Cartridges (3 pack)
40X8420 Fuser Maintenance Kit

- 40G0800** M5155, M5163, M5170, XM5163, XM5170 250-Sheet Tray
40G0801 M5155, M5163, M5170, XM5163, XM5170 250-Sheet Tray Insert
40G0802 M5155, M5163, M5170, XM5163, XM5170 550-Sheet Tray
40G0803 M5155, M5163, M5170, XM5163, XM5170 550-Sheet Tray Insert
40G0804 M5155, M5163, M5170, XM5163, XM5170 2100-Sheet Tray
40G0820 M5155, M5163, M5170, XM5163, XM5170 250-Sheet Lockable Tray
40G0822 M5155, M5163, M5170, XM5163, XM5170 550-Sheet Lockable Tray
40G0850 M5155, M5163, M5170, XM5163, XM5170 Staple Finisher
40G0851 M5155, M5163, M5170, XM5163, XM5170 Output Expander
40G0852 M5155, M5163, M5170, XM5163, XM5170 4-Bin Mailbox
40G0853 M5155, M5163, M5170, XM5163, XM5170 High Capacity Output Expander
40G0855 M5155, M5163, M5170, XM5163, XM5170 Caster Base
40G0854 Spacer (M5155, M5163, M5170)
3073173 Swivel Cabinet (M5155, M5163, M5170)

- 57X9101** 256MB User Flash Memory
57X9016 1GBx32 DDR3 RAM
57X9012 2GBx32 DDR3 RAM

- 57X9110** Traditional Chinese Font Card
57X9112 Simplified Chinese Font Card
57X9114 Korean Font Card
57X9115 Japanese Font Card

- 40G0810** M5155 Bar Code and Forms Card
40G0830 M5163 Bar Code and Forms Card
40G0840 M5170 Bar Code and Forms Card
40G0817 Card for PRESCRIBE
40G0837 Card for PRESCRIBE
40G0847 Card for PRESCRIBE

- 27X0225** MarkNet N8350 802.11b/g/n Wireless Print Server
1021294 USB (2 Meter) Cable
14F0000 Parallel 1284-B Interface Card
1021231 Parallel (10') Cable
14F0100 RS-232C Serial Interface Card

Lexmark M5100 Series Product Specifications



Product specifications

Lexmark M5155

Lexmark M5163

Lexmark M5170

Product specifications	Lexmark M5155	Lexmark M5163	Lexmark M5170
Printing			
Display	4.3-inch (10.9 cm) color touch screen with audible feedback	4.3-inch (10.9 cm) color touch screen with audible feedback	7-inch (17.8 cm) color touch screen with audible feedback
Print Speed: Up to	Black: 55 ppm	Black: 63 ppm	Black: 70 ppm
Time to First Page: As fast as	Black: 4.8 seconds	Black: 4.4 seconds	Black: 4.0 seconds
Print Resolution	Black: 1200 Image Quality, 1200 x 1200 dpi, 2400 Image Quality, 600 x 600 dpi		
Processor Speed	Dual Core, 800 MHz		
Memory	Standard: 512 MB / Maximum: 2560 MB		
Hard Disk	Option available		
Recommended Monthly Page Volume ²	3000 - 20000 pages	5000 - 50000 pages	5000 - 50000 pages
Maximum Monthly Duty Cycle: Up to ³	250000 pages per month	300000 pages per month	300000 pages per month
Supplies			
Supplies Yield	35000 ¹ -page Toner Cartridge		
Cartridge(s) Shipped With Product	Up to 10000 page ¹ Starter Toner Cartridge		
Imaging Unit	100000 pages		
Staple Cartridge (3 pack)	15000		
Paper Handling			
Paper Handling Standard	500-Sheet Output Bin, Integrated Duplex, 100-Sheet Multipurpose Feeder, 550-Sheet Input Tray		
Paper Handling Optional	250-Sheet Tray, 550-Sheet Tray, 2100-Sheet Tray, 250-Lockable Tray, 4-Bin Mailbox, 500-Sheet Staple Finisher, 1500-Sheet High Capacity Output Expander, 500-Sheet Output Expander		
Paper Input Capacity: Up to	Standard: 650 pages 20 lb or 75 gsm bond / Maximum: 4400 pages 20 lb or 75 gsm bond		
Paper Output Capacity: Up to	Standard: 550 pages 20 lb or 75 gsm bond / Maximum: 2550 pages 20 lb or 75 gsm bond		
Media Types Supported	Card Stock, Dual Web Labels, Envelopes, Integrated Labels, Paper Labels, Plain Paper, Transparencies, Refer to the Card Stock & Label Guide		
Media Sizes Supported	10 Envelope, 7 3/4 Envelope, 9 Envelope, A4, A5, A6, B5 Envelope, C5 Envelope, DL Envelope, Executive, Folio, JIS-B5, Legal, Letter, Oficio, Statement, Universal		
General			
Standard Ports	One Internal Card Slot, USB 2.0 Specification Hi-Speed Certified (Type B), Front USB 2.0 Specification Hi-Speed Certified port (Type A), Rear USB 2.0 Specification Hi-Speed Certified port (Type A), Gigabit Ethernet (10/100/1000)		
Optional Network Ports	Internal MarkNet™ N8350 802.11b/g/n Wireless / Internal RS-232C serial, Internal 1284-B Bidirectional Parallel		
Optional Local Ports	Internal RS-232C serial, Internal 1284-B Bidirectional Parallel		
Noise Level, Operating	Print: 57 dBA	Print: 57 dBA	Print: 58 dBA
ENERGY STAR	Yes		
Specified Operating Environment	Temperature: 16 to 32°C (60 to 90°F), Humidity: 8 to 80% Relative Humidity, Altitude: 0 - 3048 Meters (10,000 Feet)		
Size (in. - H x W x D) / Weight (lb.)	16.3 x 16.7 x 20.1 in. / 52.2 lb.	16.3 x 16.7 x 20.1 in. / 52.2 lb.	16.3 x 16.7 x 20.1 in. / 52.9 lb.

¹ Based on approximately 5% print coverage. Actual yields may vary based on factors such as page coverage, image type, job size, print/copy/fax modes, and duplexing.

² "Recommended Monthly Page Volume" is a range of pages that helps customers evaluate Lexmark's product offerings based on the average number of pages customers plan to print on the device each month. Lexmark recommends that the number of pages per month be within the stated range for optimum device performance, based on factors including: supplies replacement intervals, paper loading intervals, speed, and typical customer usage.

³ "Maximum Monthly Duty Cycle" is defined as the maximum number of pages a device could deliver in a month using a multishift operation. This metric provides a comparison of robustness in relation to other Lexmark printers and MFPs.



Lexmark and Lexmark with the diamond design are trademarks of Lexmark International, Inc., registered in the United States and/or other countries. All other trademarks are the property of their respective owners. ENERGY STAR® is a U.S. registered mark. Information in this document is subject to change without notice. Unison is a trademark of Lexmark International, Inc. Information in this document is subject to change without notice.

LEXMARK

KIRBO'S OFFICE SYSTEMS RENTAL CONTRACT

Date: October 1, 2014

RENTER:

Brown County Clerk
200 S. Broadway Suite 101
Brownwood, TX 76801

Phone: 325-643-2594

Contact: Sharon Ferguson

Agrees to rent: IR ADV 4245

Access: IR ADV 4245

Access: LEXMARK M5155

Access: _____

Beginning Meter Count: 101: N/A 120: _____ 109: _____ 124: _____

For a period of 60 months for which I agree to pay rental of \$499.00

Per month on the First of every month for the duration of the rental.

Rental	Delivery	Pick-up	Sales Tax:	Total
Charge <u>499.00</u>	Charge <u>0.00</u>	Charge <u>0.00</u>	Charge <u>0.00</u>	Charge <u>\$499.00</u>

VENDOR:

Kirbo's Office Systems
P.O. Box 2249
3005 Hwy 377 South
Brownwood, TX 76801
325 643 3383

Serial # QHP04991

Serial # RKM00609

Serial # 4063369908T5P

Serial # _____

Renter agrees to rent the above mentioned copier for the duration so stated in this agreement. If renter cancels for none of the reasons listed below renter is liable for the remainder of the rent payments.

Machine will be returned in as good as condition as received (reasonable wear and tear from ordinary use excepted). Renter is responsible for any damages incurred while in their possession.

Copy allowance 15,000 per month. Includes Toner XX Yes ___ No ___

Overage Rate \$0.010

THEIR WILL BE NO REFUNDS ON RENTALS AND IT IS UNDERSTOOD THAT THE RENTAL IS TO BE PAID WITHIN 10 DAYS OF THE DUE DATE OR A \$7.50 LATE CHARGE WILL BE ADDED TO THE RENTAL PAYMENT. YOU MAY CANCEL THIS AGREEMENT IF ONE OR ALL THE FOLLOWING CONDITIONS APPLY:

1. Renter needs to up-grade equipment to continue terms of contract.
2. If vendor has not provided reasonable service for unit as specified by Canon USA.
3. IF A 30 DAY WRITTEN NOTICE HAS BEEN GIVEN TO KIRBO'S OFFICE SYSTEMS PRIOR TO CANCELLATION

Upon termination of this rental agreement all outstanding payments and pick up fees (if applicable) are to be paid in full.

Upon completion, this agreement will revert to a month to month until notified by either parties.

This machine is the property of Kirbo's Office Systems and is not to be removed from the address given here without written permission.

Signatures indicate that both parties (Vendor and Renter) agree to the terms in this contract.



Kirbo's Office Systems

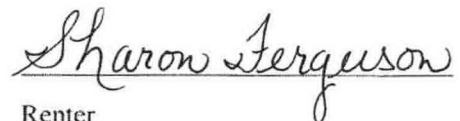

Renter

TEXAS SALES AND USE TAX EXEMPTION CERTIFICATION

Name of purchaser, firm or agency Brown County Clerk	
Address (Street & number, P.O. Box or Route number) 200 S. Broadway Suite 101	Phone (Area code and number) 325-643-2594
City, State, ZIP code Brownwood, Texas 76801	

I, the purchaser named above, claim an exemption from payment of sales and use taxes (for the purchase of taxable items described below or on the attached order or invoice) from:

Seller: **Kirbo's Office Systems**

Street address: **3005 Hwy 377 South** City, State, ZIP code: **Brownwood, TX 76801**

Description of items to be purchased or on the attached order or invoice:

Copier Lease

Purchaser claims this exemption for the following reason:

NON- PROFIT, County government

I understand that I will be liable for payment of all state and local sales or use taxes which may become due for failure to comply with the provisions of the Tax Code and/or all applicable law.

I understand that it is a criminal offense to give an exemption certificate to the seller for taxable items that I know, at the time of purchase, will be used in a manner other than that expressed in this certificate, and depending on the amount of tax evaded, the offense may range from a Class C misdemeanor to a felony of the second degree.

sign here ▶	Purchaser	Title	Date
	<i>Sharon Ferguson</i>	<i>Brown County Clerk</i>	<i>09-30-14</i>

NOTE: This certificate cannot be issued for the purchase, lease, or rental of a motor vehicle.
THIS CERTIFICATE DOES NOT REQUIRE A NUMBER TO BE VALID.
Sales and Use Tax "Exemption Numbers" or "Tax Exempt" Numbers do not exist.

This certificate should be furnished to the supplier. Do **not** send the completed certificate to the Comptroller of Public Accounts.